

VentElite

User's Manual

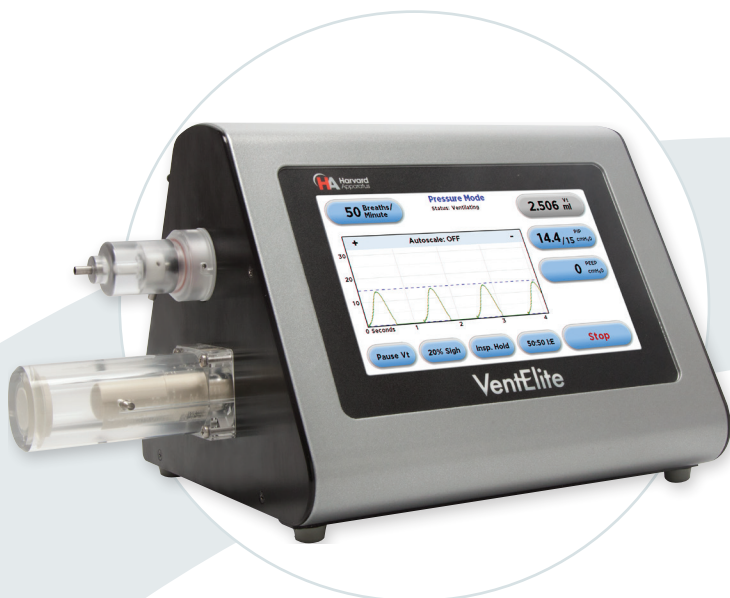

VentElite 55-7040



Table of Contents

SUBJECT	PAGE #
Warranty & Repair Information	3
Manual Description	3
Warranty	3
General Safety Information	4-5
Technical Specifications	6-7
Introduction	8
Features	9
Installation	10-12
Initial Setup	10
Location Requirements	10
Typical Operation	11
Typical Operating and Ventilator Connections	11
Airway Tubing Connections	12
Source	12
To Animal	12
From Animal	12
Exhaust	12
Operation	13-19
Getting Started	13
Mode Selection	13
Volume Mode	13
Pressure Mode	14
Setting the Respiration Rate	14
Setting the Tidal Volume	15
Setting the Peak Inspiratory Pressure (PIP)	16
I:E Ratio	16
Sigh Breath	17
Inspiratory/Expiratory Hold	18
Positive End-Expiratory Pressure (PEEP)	19
Settings	19-25
Audible Alarms	20
Backlight	21
System Information	21
Upgrade software	22
Mode	23
Y-Axis Scale	23
Running the VentElite	24
Starting Ventilation	24
Initiating a Manual Sigh Breath	24
Initiating a Manual Inspiratory/Expiratory Hold	24
Pause Vt	24
Alarms	24
Maintenance	24

Table of Contents

SUBJECT	PAGE #
Troubleshooting Guide	25
Ordering Information	25
Appendix A: PEEP Valve	26-27
Appendix B: Starting Tidal Volumes in Pressure Mode	28
Appendix C: Using Pressurized and/or Anesthetic Gases	28
Appendix D: Application Note - Volume Delivery Check	29
Appendix E: Digital I/O	30
Appendix F: Error Codes	30
Appendix G: Driver Installation	31-33

Warranty & Repair Information



REFER TO SAFETY INFORMATION AND SETTING UP THE HARVARD APPARATUS VENTELITE BEFORE PLUGGING IN THE VENTILATOR.

Manual Description

This manual is designed to provide all operational and program information required to operate the VentElite. The functions and features are described in the Technical Specifications section.

Warranty

Harvard Apparatus warranties this instrument for a period of two years from date of purchase. At its option, Harvard Apparatus will repair or replace the unit if it is found to be defective as to workmanship or materials. This warranty does not extend to damage resulting from misuse, neglect or abuse, normal wear and tear, or accident. This warranty extends only to the original consumer purchaser.

IN NO EVENT SHALL HARVARD APPARATUS BE LIABLE FOR INCIDENTAL OR CONSEQUENTIAL DAMAGES. Some states do not allow the exclusion or limitation of incidental or consequential damages so the above limitation or exclusion may not apply to you. **THERE ARE NO IMPLIED WARRANTIES OF MERCHANTABILITY, FITNESS FOR A PARTICULAR USE, OR OF ANY OTHER NATURE.** Some states do not allow this limitation on an implied warranty, so the above limitation may not apply to you.

If a defect arises within the two year warranty period, promptly contact **Harvard Apparatus, 84 October Hill Road, Holliston, Massachusetts 01746** using our toll free number 1-800-272-2775, or outside the U.S. call 508-893-8999. Our E-mail address is support@hbiosci.com. Goods will not be accepted for return unless an RMA (returned materials authorization) number has been issued by our customer service department. The customer is responsible for shipping charges. Please allow a reasonable period of time for completion of repairs or replacement. If the unit is replaced, the replacement unit is covered only for the remainder of the original warranty period dating from the purchase of the original device.

This warranty gives you specific rights, and you may also have other rights which vary from state to state.

Repair Facilities and Parts

Harvard Apparatus stocks replacement and repair parts. When ordering, please describe parts as completely as possible, preferably using a part number obtained from our Technical Support department. If practical, enclose a sample part or sketch. We offer a complete reconditioning service.

Serial Numbers

All inquires concerning our products should refer to the serial number of the unit, located on the rear panel.

General Safety Information

Please read the following safety precautions to ensure proper use of your VentElite. If the equipment is used in a manner not specified, the protection provided by the equipment may be impaired.

To Prevent Hazard or Injury

Use Proper Power Supply

The unit is supplied with an approved power supply and line cord. To maintain the safety integrity of the device, use only the following:

Globtek Inc.	
Model:	GT-43006-4015-T3
Output:	15V DC, 2.7 A
Input:	100-240V, 50/60 Hz, 1.0 A

Use Proper Line Cord

Use only the specified line cord for this product and make sure the line cord is certified for the country of use. The operating voltage range for the VentElite is 15 VDC. The universal power supply operating voltage range is 100-240 VAC, 50/60 Hz.

Ground the Product

This product is grounded through the grounding conductor of the line cord. To avoid electric shock, the grounding conductor must be connected to earth ground. Before making any connections to the input or output terminals of the product, ensure that the product is properly grounded.

Make Proper Connections

Make sure all connections are made properly and securely. Any signal wire connections to the unit must be no longer than 3 meters.

Observe All Terminal Ratings

Review the operating manual to learn the ratings on all connections.

Avoid Exposed Circuitry

Do not touch any electronic circuitry inside of the product.

Do Not Operate with Suspected Failures

If damage is suspected on or to the product do not operate the product. Contact qualified service personnel to perform inspection.

Orient the Equipment Properly

Do not orient the equipment so that it is difficult to operate the disconnection device.

General Safety Information

Place Product in Proper Environment

Review the operating manual for guidelines for proper operating environments.

Observe All Warning Labels on Product

Read all labels on product to ensure proper usage.



CAUTION
Refer to Manual



Protective
Ground Terminal



CAUTION: FOR RESEARCH USE ONLY. NOT FOR CLINICAL USE ON PATIENTS.

Technical Specifications

Suggested Weight Range	10 g to 1 kg
Species	Mouse to Guinea Pig
Port Sizes	
To Animal and Source	3.6-3.8 mm (0.14-0.15 in)
From Animal and Exhaust	4.0 mm (0.16 in)
Control Modes	Volume or Pressure
Tidal Volume Range	50 µl to 5 ml
Tidal Volume Accuracy	0.1 µl
Tidal Volume Resolution	1 µl
Peak Inspiratory Pressure (PIP)	0-50 cmH ₂ O
PIP Accuracy	± 0.7 cmH ₂ O*
PIP Resolution	1 cmH ₂ O
PEEP	0-10 cmH ₂ O
Breath Rate	10 to 300 bpm
I:E Ratio	20-80%
Gas Supply	Room air or nonflammable mixed gas**
Sigh Frequency	Every 10 – 999 breaths or manual
Sigh Breath	0-20% of tidal volume (in Volume Mode) or PIP (in Pressure Mode)
Safety Alarms	Over- and under-pressure, occlusion, high PEEP
Signal Input	TTL, 0-5 VDC
Signal Output	TTL, 0-5 VDC, 5 mA
Remote Communication	RS-485
Display	7" LCD touchscreen, resistive
Power Supply	100-240 VAC, 50/60 Hz
Input Power	15V DC, 25 W
Input Power Connector	2.5 mm ID x 5.0 mm OD plug
Dimensions (W x D x H)	31.8 x 20.3 x 17.8 cm (12.5 x 8.0 x 7.0 in)
Weight	3.4 kg (7.6 lbs)
Warranty	2 years

*PIP accuracy is a reflection of the most ideal condition and may differ depending on specific set up

Use of a pressurized gas source with the VentElite requires the use of a connection kit; please see **Appendix B for details.

Technical Specifications

Atmospheric Specifications	
Operating Temperature	4°C to 40°C (40°F to 104°F)
Storage Temperature	-10°C to 70°C (14°F to 158°F)
Operating Humidity	See Chart Below
Storage Humidity	20% to 80% RH, non-condensing
Method of Operation	Continuous
Classification	Class I
Pollution Degree	1
Installation Category	II
Supplier Name	Harvard Apparatus
Supplier Address	84 October Hill Road, Holliston, MA 01746
Regulator Certifications	CE, ETL (UL, CSA), WEEE, & EU RoHS
Safety Declarations	ANSI/UL 61010-1; CAN/CSA C22.2. No. 61010-1; IEC 61010-1; CENELEC EN 61010-1
EMC Declaration	FCC 47CFR 15B, EN61326-1

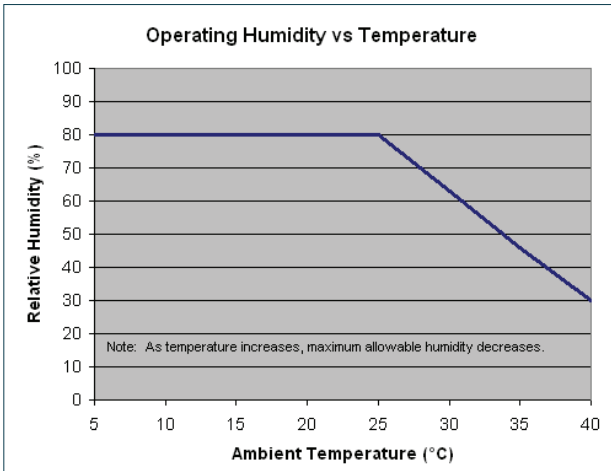

Introduction

Theory of Operation

The VentElite was designed for animal research applications and is intended for use on subjects ranging in size from mice to guinea pigs. The design goal of this ventilator was to maintain versatility and ease of use while fostering safe and physiologically accurate mechanical ventilation conditions.

The VentElite utilizes advanced technologies to precisely control respiration profiles. The VentElite has two operating modes, Volume Control and Pressure Control, and allows users to easily toggle between these two modes via the Settings button on the large touch screen. The Volume Control mode delivers the desired tidal volume to the subject by precisely controlling the stroke of the piston. Since the actual stroke length, and therefore tidal volume, may be modified for a given stroke, sigh breaths are supported. Similarly, since stroke speed is precisely controllable during inspiration and expiration, variable inspiration-to-expiration (I:E) ratios are also supported. A pressure sensor continuously monitors the airway pressure to alert the user of over- and under-pressure conditions.

The Pressure Control mode of the VentElite allows the user to set the peak inspiratory pressure (PIP) value. Flow rates are automatically adjusted by changing the tidal volume while keeping the respiration rate constant. The stroke is adjusted in a manner in which the PIP is reached near the end of the piston stroke. This ensures that the subject, which has a higher airway resistance than the airway path within the ventilator, receives the majority of the expected tidal volume and that the unit does not prematurely terminate the piston stroke. Manual adjustment of the inspiratory flow rate is not required.

The VentElite offers built-in Positive End Expiratory Pressure (PEEP) capability, allowing a PEEP setting via the touch screen user interface of up to 10 cmH₂O. Another feature of the VentElite is the ability to perform Inspiratory or Expiratory Hold. The user can enter the desired hold time and initiate inspiratory or expiratory hold by simply pressing the Insp. Hold/Exp. Hold button on the user interface.

Features

Volume Control Mode	The VentElite delivers a known volume of gas to the subject on each inspiration stroke. Respiration frequency and I:E ratio determine the amount of time for inspiration and expiration phases.
Pressure Control Mode	The ventilator delivers gas to the subject until the user-defined pressure limit is reached. Stroke volume is automatically adjusted by the unit so that the pressure limit is reached near the end of the stroke. Respiration frequency and I:E Ratio determine the amount of time for inspiration and expiration phases
Tidal Volume (Vt)	Adjustable from 50 μ l to 5 ml with user selectable units
Respiratory Rate (BPM)	Adjustable from 10 to 300 BPM
Adjustable I:E Ratio	This option allows the user to select the ratio of inhalation to exhalation times when advanced respiratory control is needed. This feature is intended to allow greater respiratory control for research applications. The default I:E ratio is 50% and is user selectable from 20 to 80%, depending on respiration rate.
Sigh Breath	Continuous, long-term ventilation combined with the force of gravity will cause the animal's lungs to collapse. Introducing a larger than normal tidal volume over-inflates the animal's lungs, replicating a natural sigh. This allows the lungs to expand and open the collapsed alveoli. Sigh breaths are supported in both Volume Control and Pressure Control modes. In the Volume Control mode, a sigh tidal volume is used. In the Pressure Control mode, a sigh pressure limit is used. The frequency and volume of the sigh breath are user selectable via the Sigh button on the user interface. Sigh frequency can be programmed automatically or can be controlled manually by pressing the Sigh button on the user interface.
Positive End Expiratory Pressure (PEEP)	Positive End Expiratory Pressure (PEEP) is user selectable, up to 10 cmH ₂ O, depending on peak inspiratory pressure (PIP).
Inspiratory/Expiratory Hold	User selectable option for toggling between inspiratory or expiratory hold, for user defined time to maintain peak (inspiratory) or minimal (expiratory) tidal volume/pressure in the subject's lungs
Safety Alarms	Visual and audible alarms for over pressure, under pressure, occlusion, and high PEEP – as well as option to Mute All alarms

Installation



Front and Back of the VentElite

Initial Setup

1. Remove unit from the box
2. Remove foam-packing inserts from both ends of the ventilator
3. Locate and carefully remove the power supply and line cord from the shipping material
4. Visually inspect the ventilator for any damage that might have occurred in the shipping process
5. The VentElite is shipped from the factory with a North American line cord with a US three wire molded power plug on one end and an IEC320/C13 connector on the other end. Use only an approved AC line cord with a molded IEC320/C13 connector certified for country of use. Only connect to grounded power receptacles to help ensure proper grounding; do not use adapter plugs.
6. Read the manual to become familiar with all features and functions of the VentElite

Location Requirements

- A sturdy, level, clean, nonflammable and dry surface
- Minimum of 2.5 cm (1 in) clearance around the ventilator
- Adequate power supply
- Room temperature 4° to 40°C (40° to 104°F)
- Relative humidity of 20 to 80% (see chart in Technical Specifications section)
- A well ventilated room



WARNING

**Do not use in the presence of explosive gases
or in a high concentration oxygen environment**

Installation

Typical Operation

The VentElite is designed to respire small animals with a body mass ranging from 10 g to 1 Kg. It can operate at respiration rates of 10 to 300 breaths per minute (bpm) and can deliver tidal volumes of 50 μ l to 5 ml. The VentElite is designed for use in a typical laboratory, operating room, or any other well-ventilated, nonexplosive environment. The VentElite can be used to deliver all types of nonexplosive gas mixtures including, but not limited to, anesthetic gases and high concentration oxygen.

T

The VentElite has connection ports on the piston and cylinder as well as on the valve outlet. These connections are shown and explained below and on the following pages.



Installation

Airway Tubing Connections

Source

Flow of gas used by VentElite for inspiration. Connect to the source of inspiration gas or leave disconnected to use room air for ventilation.

To Animal

Flow of gas from ventilator to the animal.

From Animal

Flow of expired gas from animal to ventilator.

Exhaust

Flow of expired air from the ventilator. This gas may be vented to the room, collected, and/or filtered if chemicals are present in the expired air.

Note: *If gas anesthesia is used in conjunction with the VentElite, proper scavenging must be utilized to ensure safe evacuation of the halogenated waste gas.*

CAUTION: Do NOT vent anesthesia gases to room, proper scavenging methods must be used. Contact our Technical Services team for more information or options.

CAUTION: Do NOT connect VentElite to pressurized gas sources unless proper pressure regulation is provided to equalize the pressure with atmospheric pressure. Failure to do so could result in excessive and unknown tidal volumes delivered to the animal. Harvard Apparatus suggests the connection kits, 73-4872 for use in this application.

Rear Panel close up

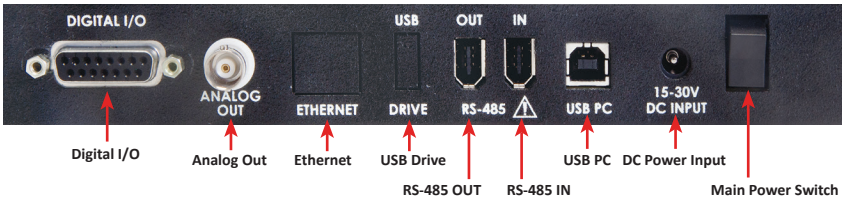

Operation

Getting Started

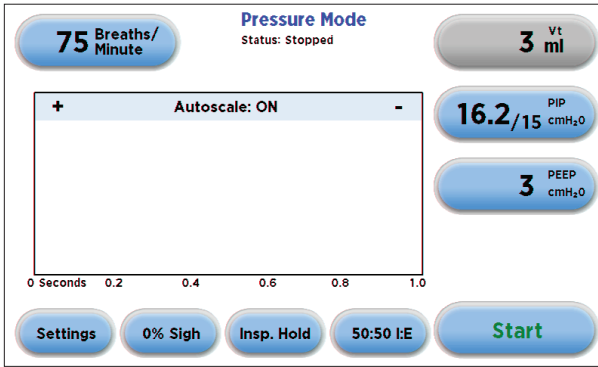



1. Turn VentElite on and wait for the valve assembly to return to the home position

Mode Selection

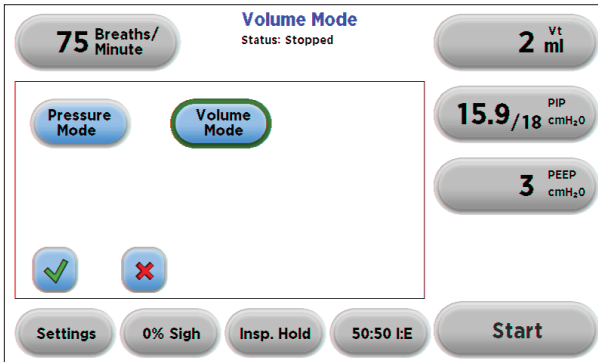
Volume Mode



1. From the **Settings Screen** enter the **Mode Selection Screen** by selecting the **Mode** button
2. Select **Volume Mode**
3. Accept the changes made by pressing the  and return to the main screen
OR Cancel the changes made by pressing the  and go back to the main screen

Operation

Pressure Mode

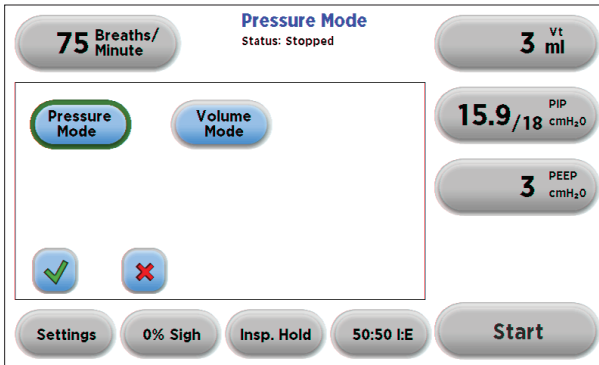

1. From the **Settings Screen** enter the **Mode Selection Screen** by selecting the **Mode** button
2. Select **Pressure Mode**
3. Accept the changes made by pressing the and return to the main screen
OR Cancel the changes made by pressing the and go back to the main screen

Setting the Respiration Rate

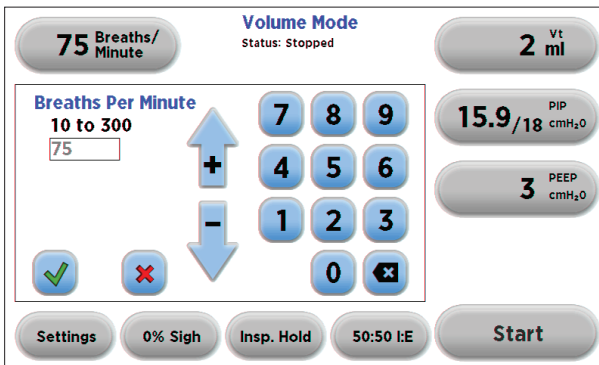



1. Set the respiration rate by selecting the **Respiration Rate** button in the top left corner of the display screen
2. Use the keypad, or up and down arrows, to enter the desired respiration rate from 10 to 300 breaths per minute
3. Accept the changes made by pressing the and return to the main screen
OR Cancel the changes made by pressing the and go back to the main screen

Operation

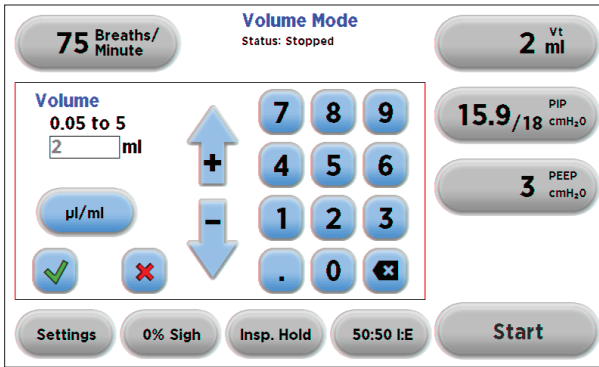
Setting the Tidal Volume (Volume Mode only)





1. Set the tidal volume by selecting the **Tidal Volume** button in the top right corner of the display screen
2. Use the **Unit Selection** button under the selected volume box to toggle between μl and ml
3. Use the keypad, or up and down arrows, to enter the desired tidal volume from 50 μl to 5 ml per breath
4. Accept the changes made by pressing the  and return to the main screen
OR Cancel the changes made by pressing the  and go back to the main screen

Note: Tidal Volume is only user defined in the Volume Mode. You cannot choose the Tidal Volume in Pressure mode as it is calculated to maintain the target peak inspiratory pressure (PIP).

Operation

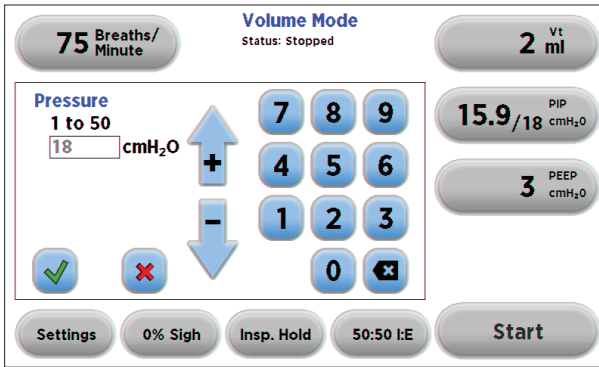
Setting the Peak Inspiratory Pressure (PIP)



1. Set the peak inspiratory pressure (PIP) by selecting the **PIP** button on the right side of the display screen (second button from the top)
2. Use the keypad, or up and down arrows, to enter the desired PIP from 1 to 50 cmH₂O
3. Accept the changes made by pressing the  and return to the main screen
OR Cancel the changes made by pressing the  and go back to the main screen

Note: PIP can, and should, be set in Volume Mode. In Volume Mode the PIP serves as a desired maximum PIP that the user does not wish to exceed. The set value should not be reached except in unexpected conditions such as a blockage in the tubing. When the PIP is reached in volume mode, the full set volume will not be delivered.

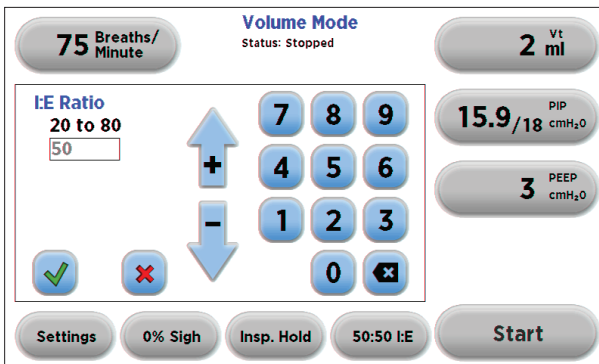

I:E Ratio



1. To change the ratio of inspiration to expiration time from the default 50:50 select the **I:E** button located on the bottom of the display screen, to the left of the start button

Operation



I:E Ratio (continued)

2. Use the keypad, or up and down arrows, to enter the desired I:E ratio from 20:80 to 80:20
3. Accept the changes made by pressing the  and return to the main screen
OR Cancel the changes made by pressing the  and go back to the main screen

Note: Depending on the respiration rate, the acceptable I:E range may differ

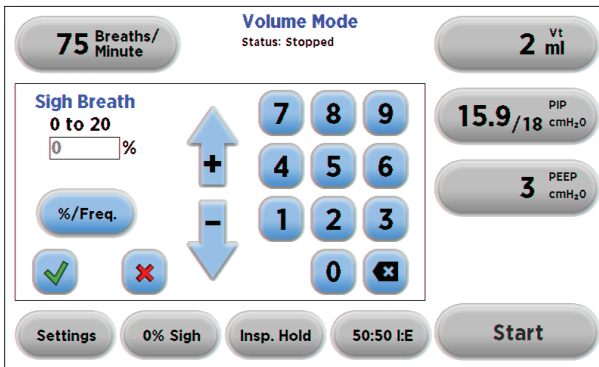
Sigh Breath





1. To set a sigh breath select the **Sigh** button located on the bottom of the display screen, to the right of the Settings button
2. Use the keypad, or up and down arrows, to select the % you would like the sigh breath to increase
3. Use the %/Freq. button to toggle from % to frequency
4. Use the keypad, or up and down arrows, to select the desired frequency of the sigh breath. For a manual breath only use 0
5. Accept the changes made by pressing the  and return to the main screen
OR Cancel the changes made by pressing the  and go back to the main screen

Note: In Volume Mode the entered sigh is a percentage increase in the tidal volume.
In Pressure Mode the entered sigh is a percentage increase in the PIP.

Operation

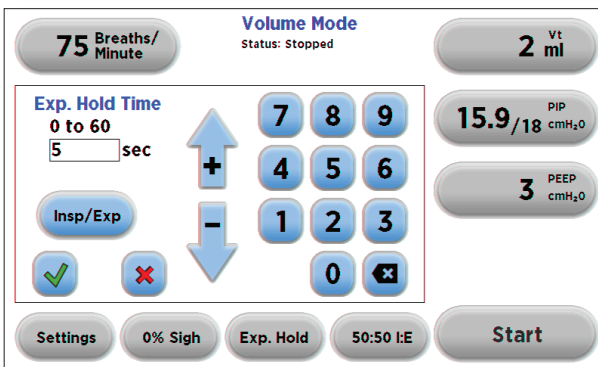
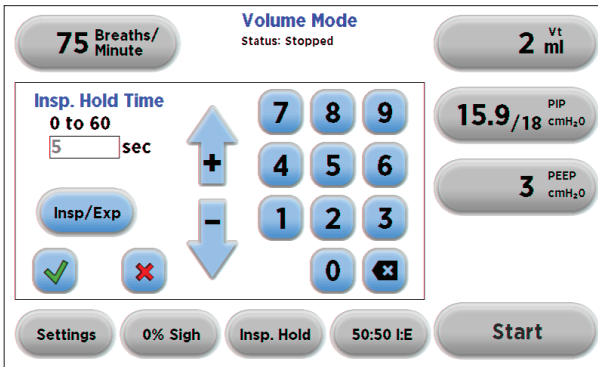
Inspiratory/Expiratory Hold



1. Set the Inspiratory Hold by selecting the **Insp. Hold** button located on the bottom of the display screen
2. Use the keypad, or up and down arrows, to enter the desired Inspiratory Hold time from 0 to 60 seconds
3. Use the **Insp/Exp** button to toggle between setting an Inspiratory or Expiratory hold
4. Accept the changes made by pressing the  and return to the main screen
OR Cancel the changes made by pressing the  and go back to the main screen

Note: While you are able to set either an inspiratory or expiratory hold, you are unable to set both an inspiratory and expiratory hold simultaneously; you can choose to program one or the other.

Operation

Positive End-Expiratory Pressure (PEEP)

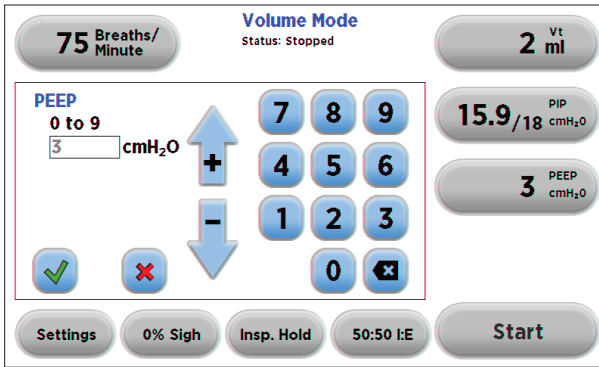

1. To set a PEEP select the **PEEP** button on the right side of the display screen
2. Use the keypad, or up and down arrows, to enter the desired PEEP from 0 to 10 cmH₂O
3. Accept the changes made by pressing the and return to the main screen
OR Cancel the changes made by pressing the and go back to the main screen

Note: The maximum PEEP allowed may differ depending on the PIP setting. Please see Appendix A for more detailed information on setting the PEEP.

Settings

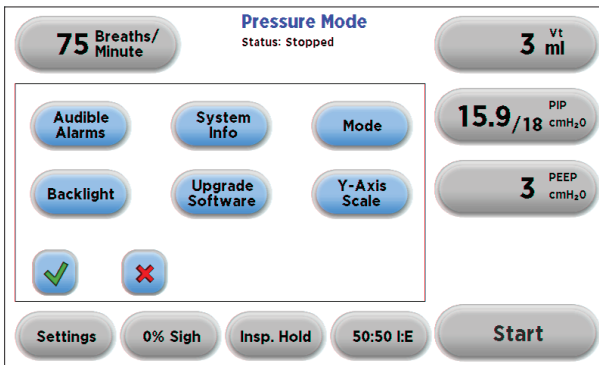

Settings options include the following:

- Audible Alarms
- Backlight
- System Information
- Upgrade Software
- Mode
- Y-Axis Scale

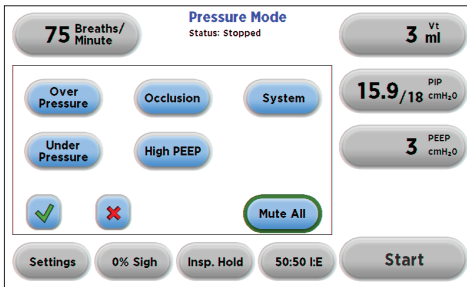
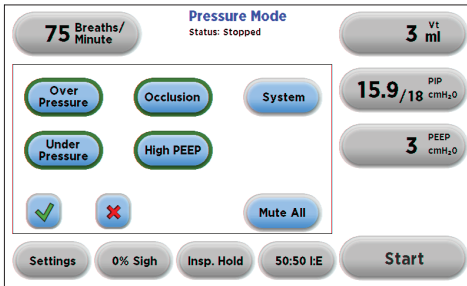

Settings

Audible Alarms



The VentElite has several Audible Alarms that the user can choose to mute should they wish. These alarms are:

- **Over Pressure:** Indicates the PIP is greater than the pressure readback by more than 10%
- **Under Pressure:** Indicates that the pressure readback at end of inhalation is 80% less than the set PIP
- **Occlusion:** System detects a drastic increase in pressure of 30% or more above the PIP, indicating an occlusion may be present
- **High PEEP:** Pressure reading at end of exhalation is at least 1 cmH₂O higher than the set PEEP
- **System Alarms**

1. In the Settings screen, select **Audible Alarms**
2. A green ring around the alarm button indicates that the audible alarm is activated. Mute an individual alarm by pressing the button and the green ring will disappear; this indicates that the alarm is muted
3. Mute all alarms by pressing the **Mute All** button
4. Accept the changes made by pressing the  and return to the main screen
OR Cancel the changes made by pressing the  and go back to the main screen

Settings

Backlight

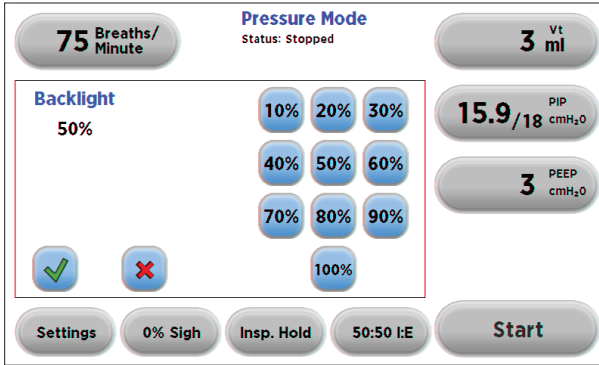

1. In the Settings screen, select **Backlight**
2. Select the desired % Backlight. For example, if you select 80%, the brightness of the display will be 80% of the maximum
3. Accept the changes made by pressing the and return to the main screen
OR Cancel the changes made by pressing the and go back to the main screen

System Information

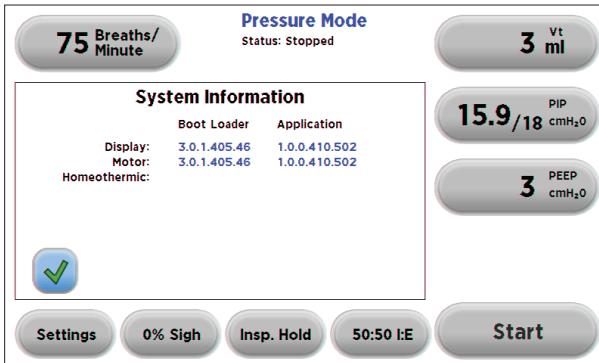

This setting allows you to view the version of the software that is currently on the VentElite. The button allows you to exit and return to the main screen.

Settings

Upgrade Software

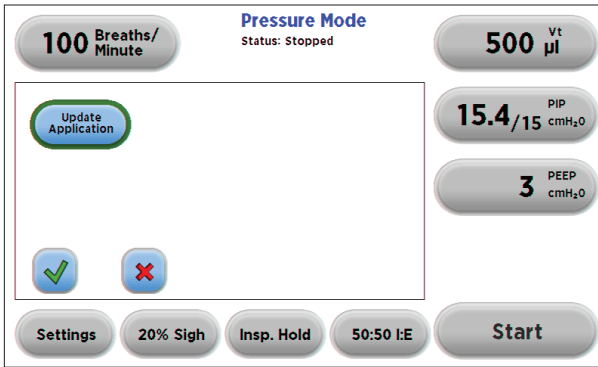



1. Install the VentElite USB driver and bootloader driver on your computer (see appendix B for details). Both drivers are located on the CD that was provided with your unit
2. Upload the latest software version to your desktop (the format is filename.srec)
3. Disconnect all I/O devices and then connect the VentElite to the PC using a USB cable
4. On the Settings screen of the VentElite, press the **Upgrade Software** button
5. On the Update Screen, select the **Update Application** button and press the 
6. From the CD provided with the system, open the **VentElite Update Application**
7. Click **Open Update File** and browse to the file previously saved on your desktop and click Open
8. Click **Status Update**
9. After the update is complete, press **Reboot** to power cycle the VentElite

Settings

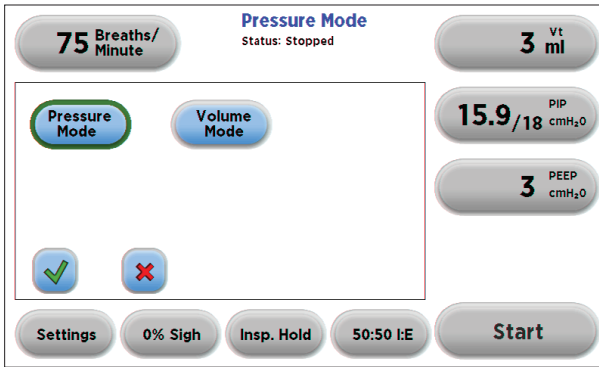

Mode

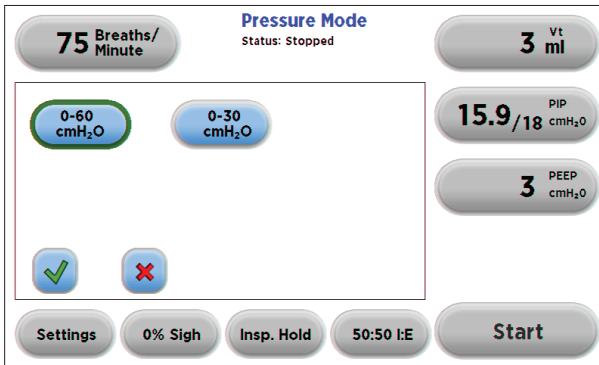

1. In the Settings screen, select **Mode**
2. Select the desired mode, **Pressure** or **Volume**. A green ring will appear around the button, indicating the mode has been selected
3. Accept the changes made by pressing the  and return to the main screen
OR Cancel the changes made by pressing the  and go back to the main screen

Y-Axis Scale



1. In the Settings Screen, select **Y-Axis Scale**
2. Select the desired y-axis scale, 0-60 or 0-30 cmH₂O, depending on your expected pressures. A green ring will appear around the button, indicating the axis scale has been selected
3. Accept the changes made by pressing the  and return to the main screen
OR Cancel the changes made by pressing the  and go back to the main screen

Settings

Running the VentElite

Once the desired parameters have been entered, the appropriate tubing has been connected, and the subject is in place; hit Start button. The VentElite status will be displayed as “Ramping” as the ventilator starts running. While ramping, the Settings button will be inactive. Once the piston/cylinder assembly is ready the VentElite status will become “Ventilating.”

Starting Ventilation

Initiating a Manual Sigh Breath

1. Ensuring that the desired sigh percentage is set and that sigh frequency is set to 0 (see Getting Started, Sigh Breath page 16)
2. Press and hold the **Sigh** button for 3 seconds. The sigh breath is delivered upon release of the button

Initiating a Manual Inspiratory/Expiratory Hold

1. Ensuring that the desired inspiratory or Expiratory Hold time is set (see Getting Started, Inspiratory/Expiratory Hold page 17)
2. Press and hold the **Insp/Exp Hold** button for 3 seconds. The hold is initiated upon release of the button

Pause Vt (Pressure Mode only)

While the ventilator is running in Pressure mode, the Settings button is replaced by a Pause Vt button. The purpose of this button is to temporarily turn off the volume adjust function of the VentElite in response to the pressure reading, which occurs in pressure mode. This is useful as it allows the user to momentarily disconnect an animal should any adjustments need to be made without the ventilator detecting an under pressure and increasing the tidal volume. This is important as it avoids an unnecessary increase in tidal volume when the animal is reattached to the ventilator.

Note: *This feature is in Pressure mode only. It is not available in Volume mode as the tidal volume remains constant in Volume mode, regardless of the pressure feedback. While the ventilator is running in Volume mode, the Settings button will remain visible, but will be inactive.*

Alarms

While the unit is running alarms will be visible even if the audible alarm has been muted. Error codes and the corresponding descriptions (see Appendix D) will appear on the main screen under the mode. In addition, pressure and volume warnings and alarms will be indicated by yellow and red rings around the Vt and PIP buttons.

Maintenance

The VentElite requires no special onsite maintenance other than keeping the unit clean and dry. To clean exterior surfaces, use a lint-free cloth to remove dust. Use care to

Settings

avoid scratching the display. For more efficient cleaning, use a soft cloth dampened (not soaked) with water, 75% Isopropyl alcohol, or mild detergent.

The valve head on the exterior of the unit has a removable cover. To remove this cover simply rotate the cover and pull it out from the body of the VentElite. The cover can then be washed and flushed out to remove buildup that may occur. In addition to the cover, the valve head itself should also be cleaned to remove any build up that may occur. Once cleaned, be sure to allow the valve head and cover to dry completely. Once dry, the valve head cover can be replaced by sliding it over the valve head and rotating it to lock it into place.

It is recommended that the VentElite be sent in annually for preventative maintenance to ensure that unit is running optimally. Part # 55-7041PM.



Warning – Do NOT run liquid through the cylinder.

Troubleshooting Guide

Unit will not power On	Ensure that power supply and cord are securely plugged into unit and outlet. Ensure that outlet is live.
Under Pressure	Check for leak in tubing. Check for leak in the intubation or tracheotomy.
Over Pressure	Check for blockage or kink in tubing. Ensure that the tubing between the ventilator and the animal is short enough.
Occlusion	Check for blockage between the ventilator and the animal.

Ordering Information

Order #	Product
55-7040	VentElite, Ventilator for Small Rodents*
73-4876	Respiration Tube Kit for VentElite, Rat
73-4899	Respiration Tube Kit for VentElite, Mouse
73-4872	Connection Kit for VentElite

* Requires the use of the 73-4872 Connection Kit when used with a high pressure gas source.

Appendix A: Peep Valve

Addendum to Manual – PEEP Valve

Introduction

The VentElite offers the ability to set and maintain a Positive End-Expiratory Pressure (PEEP) within the ventilator itself. By doing this, in addition to the obvious advantage of eliminating the need for a column of water, users are also able to set a PEEP and safely scavenge anesthetic gas. There are two components used to set and maintain a PEEP in the VentElite: (1) Software setting, and (2) PEEP Valve. Below are instructions for successfully setting and maintaining a PEEP in the VentElite.

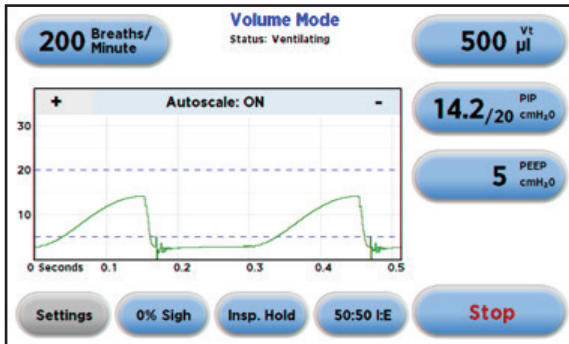

Before PEEP Valve is utilized

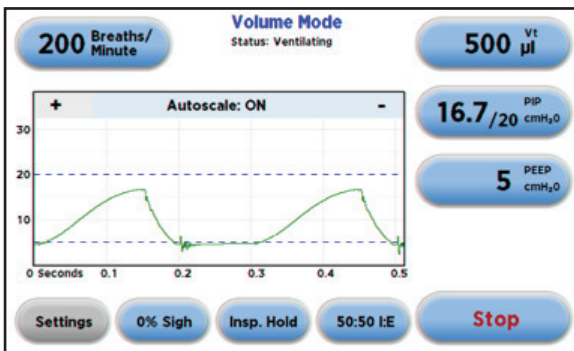

Once PEEP Valve has been set

Appendix A: Peep Valve

Maintaining PEEP

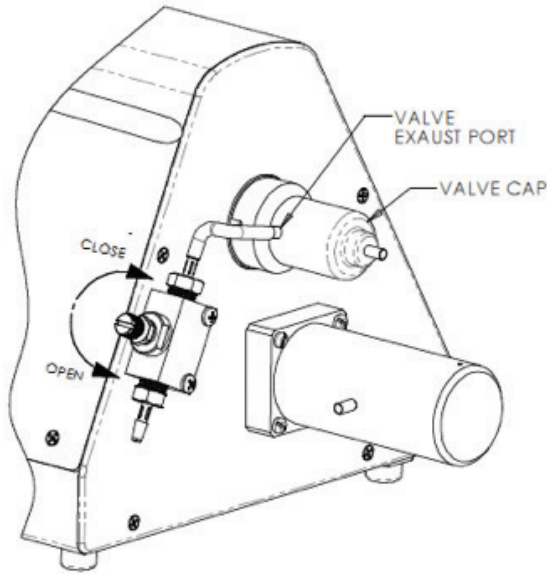

1. Set desired PEEP on the VentElite (see page 18 of User's Manual for detailed instructions)
2. Ensure that the valve is completely open by turning the valve knob all the way in the "Open" direction (see figure above)
3. Hit Start on the VentElite to begin ventilation
4. As VentElite is running, slowly turn the valve knob in the "close" direction, and adjust as needed until PEEP is adequately maintained.

NOTE: Be sure not to fully close the valve. If closed, the ventilator will detect an occlusion and eventually stop running once pressure is high enough.

Appendix B: Starting Tidal Volumes in Pressure Mode

In Pressure mode, the VentElite will use the set Respiration Rate as a guide to determine the approximate tidal volume to deliver. Below is a chart detailing the starting tidal volumes based on the set respiration rate. The VentElite will adjust the volume from these starting points accordingly to hit the target PIP.

Respiration Rate	Starting Tidal Volume
0-74	3 ml
75-99	2 ml
100-149	500 µl
150-199	100 µl
200-300	50 µl

Appendix C: Using Pressurized and/or Anesthetic Gases

The VentElite was designed to operate utilizing gas sources of atmospheric pressure. When pressurized, constant flow devices are used with the VentElite (such as regulators, flowmeters, and house gas supplies) measures must be taken to ensure no damage is done to the unit. We recommend the use of our connection kit when using a high pressure gas source with the VentElite, or any of our ventilators. The connection kit prevents the buildup of pressure from constant flow devices such as those referenced above. Below is a schematic of the connection kit. The appropriately sized connection kit for the VentElite is the 73-4872 connection kit.

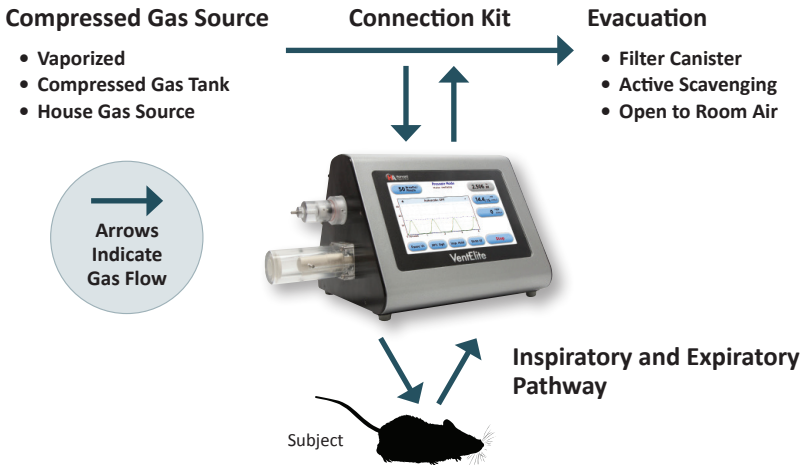

Appendix D: Application Note

Volume Delivery Check

While it is always recommended to use the shortest length of tubing possible between the ventilator and the animal, depending on the setup users may prefer varying lengths. Due to the fact that air is compressible, it is possible to see a reasonable airway pressure measurement on screen without guaranteeing air delivery to the subject. To correct for this, it may be necessary to use a slightly higher volume than reported in publications. This situation is especially prevalent with mice due to the low lung volumes.

Below are steps to take to verify that the animal is receiving air delivery as intended. This should only need to be done once per set up, so long as the tubing is not changed out. Anytime the tubing is changed this process should be repeated.

1. Select **Volume Mode** on the VentElite (see Getting Started, Mode Selection, page 12)
2. Set desired parameters on VentElite for running in Volume Mode (see Getting Started, pages 12-18)
3. Immerse the end of the tubing in water. The tubing should not be submerged more than about 0.5 cm under the surface of the water.
4. Press Start
5. Verify that bubbles are coming from the end of the tubing. Assuming bubbles are seen, skip to step 6
6. If no bubbles are seen, a higher tidal volume is required to compensate for the compliance of the tubing. Increase set tidal volume in small steps until bubbles are seen
7. Once bubbles are seen, remove the tubing from the beaker of water, connect the animal, and begin ventilation

Note: *Be sure not to allow water to creep all the way up the tubing and into the piston*

Note: *A typical Peak Inspiratory Pressure (PIP) is 12 to 15 cmH₂O. If measured PIP is less than this, even if bubbles are seen, tidal volume should be increased until a PIP in this range is maintained. Operating under a PIP of 12 cmH₂O may cause the animal to begin gasping for breath, which is a sign of poor O₂-CO₂ exchange.*

Appendix E: Digital I/O

Pin (DB15)	Signal	Description
1	HOLD_OUT	Output for Hold event
2	SIGH_OUT	Output for Sigh event
3	SYNC_OUT	Output showing Run state
4	I/E_OUT	Output showing Inhale/Exhale state
5	SIGH_I	Input to cause Sigh event
6	HOLD_I	Input to cause Hold event
7	RUN/STOP	Input to Start/Stop ventilator
8	IN1	Trigger Input (inactive)
9-15	GND	GND

Appendix F: Error Codes

The VentElite error conditions are categorized into 4 groups: **PIP** errors, **PEEP** errors, **Volume (Vt)** errors, and **System** errors. Error codes are displayed as a group of five characters (0-9 or A-F), where the second character contains the System status, the third is the Vt status, the fourth is the PEEP status and the fifth is the PIP status.

For each group, a status of 0 means no error. The meanings of each non-0 error code are listed below. Examples:

- (1) an error code of 00006 would mean PIP error 6 is active, and no PEEP, Vt, or System alarms are active.
- (2) an error code of 00355 would indicate PIP error code 5, PEEP error code 5, Vt error code 3, and no System error codes are active.

Error conditions are displayed with the error code and an error text string. If more than one of the four error code characters is non-zero, the error text will be displayed as "Multiple Errors".

In the table on page 31, R/Y indicates whether the error is considered an alarm (Red) or a warning (Yellow). The PIP button will include a ring of Red or Yellow to indicate a PIP alarm or warning condition, respectively. Similarly, the PEEP and Vt buttons will include a Red or Yellow ring to indicate the level of any error condition in their groups.

Appendix F: Error Codes

Error Group	R/Y	Error Code (Text)	Meaning
PIP	R	x1xxx (Under pressure)	Pressure is remaining at less than 10% of PIP set point
PIP	Y	x2xxx (Under pressure)	Pressure is above 10% of PIP set point, but is remaining at less than 20% of PIP set point
PIP	R	xxx3 (Increasing average PIP)	Pressure exceeds average pressure by more than 20%.
PIP	Y	xxx4 (Increasing average PIP)	Pressure exceeds average pressure by more than 10% but less than 20%.
PIP	R	xxx5 (Over pressure)	Pressure exceeds PIP set point.
PIP	Y	xxx6 (Over pressure)	Pressure between 90% and 100% of PIP set point.
PEEP	Y	xx5x (High PEEP)	Average PEEP exceeds the PEEP set point by more than 1 cmH2O.
Vt	R	x1xx (Declining Average Vt)	PIP volume is less than 10% of the previous average volume.
Vt	Y	x2xx (Declining Average Vt)	PIP volume is between 10% and 20% of the previous average volume.
Vt	R	x3xx (Maximum Vt)	PIP volume exceeds the maximum supported volume of 5 mL.
Vt	Y	x4xx (High Vt)	PIP volume exceeds the 90% the maximum supported volume of 5 mL, but is not at the maximum volume.
Vt	R	x5xx (Low Vt)	PIP volume is less than 10% of PIP set point.
Vt	Y	x6xx (Low Vt)	PIP volume is less than 20% of PIP set point, but greater than 10% of PIP set point.
System	R	1xxx (BioBus Error)	Internal communications error.
System	R	3xxx (Check Piston)	Piston motor stall.
System	R	5xxx (Check Valve)	Valve motor stall.
System	R	7xxx (Check Volume motor)	Volume motor stall.
System	R	Bxxx (Please Recycle Power!)	Piston motor error on power up. Power cycle required.
System	R	Dxxx (Check for an occlusion)	Possible occlusion.

Appendix G: Driver Installation

Before connecting the VentElite to a computer via USB, the unit should be put into **Upgrade Software Mode**. To do this, enter the settings screen by pressing the **Settings** button on the display. Enter the **Software Update Mode** by pressing the **Upgrade Software** button, then press **Update Application**, and the **Accept** button. Once the unit is connected to the PC, Windows will seek to install drivers for communication. The following section details the installation of the Virtual CommPort Driver and the firmware updater driver supplied with the VentElite.

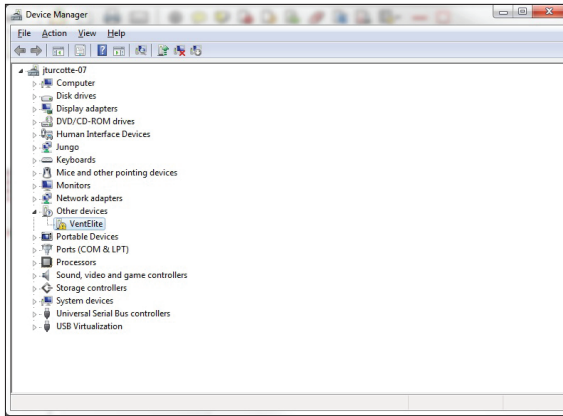

1. Connect the VentElite to the computer via USB. Open the **Control Panel** and select **System and Security** and then **System**. Select **Device Manager** on the left hand menu

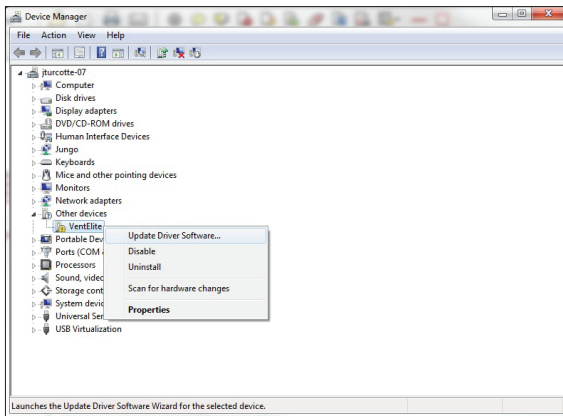

2. Two **Flash Update Applications** will be displayed in the **Device Manager** under **Other Devices**. Right click on either of the **Flash Update Applications** and select **Update Driver Software**

Appendix G: Driver Installation

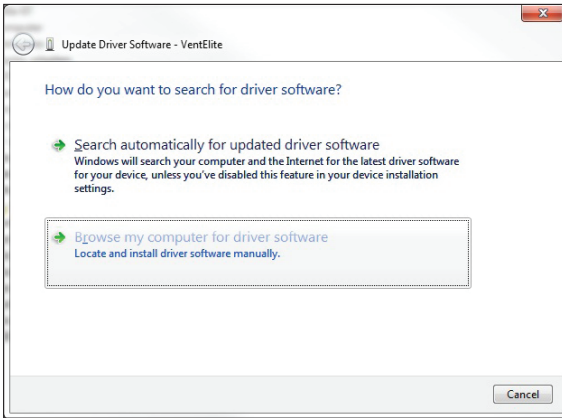

3. Select Browse **my computer** for driver software

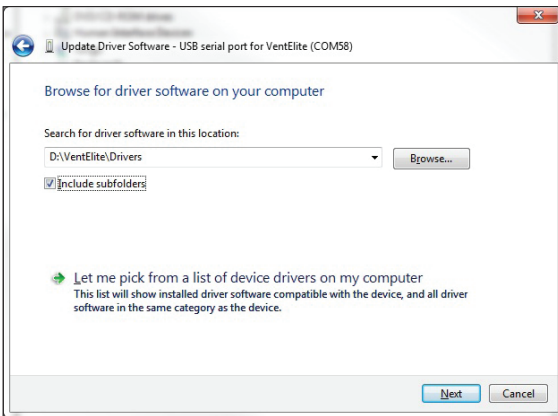

4. Click Browse and navigate to the VentElite drivers folder located on the CD supplied with the ventilator. Make sure the “Include Subfolders” box is checked and then click next

Appendix G: Driver Installation

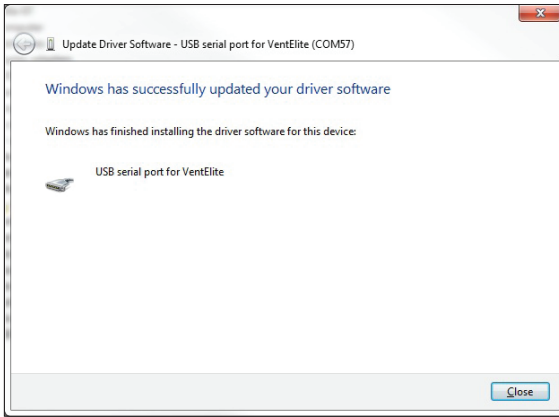

5. If a warning message regarding the driver publisher is displayed, choose **Install this driver software anyway**

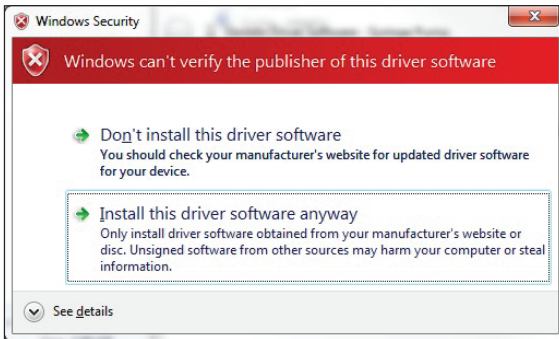

6. Click **Close** after the software has been successfully installed
7. Repeat steps 2-6 for the second Flash Update Application listed

Notes

Notes

U.S.A.

Harvard Apparatus

84 October Hill Road
Holliston, Massachusetts 01746

Phone	(508) 893-8999
Toll Free	(800) 272-2775
Fax	(508) 429-5732
E-mail	support@hbiosci.com
Web	www.harvardapparatus.com

Canada

Harvard Apparatus, Canada

6010 Vanden Abeele Street
Saint Laurent, Quebec, H4S 1R9

Phone	(514) 335-0792
Toll Free	(800) 361-1905
Fax	(514) 335-3482
E-mail	sales@harvardapparatus.ca
Web	www.harvardapparatus.ca

France

Harvard Apparatus, S.A.R.L.

6 Avenue des Andes
Miniparc – Bat. 8
F-91952, Les Ulis Cedex

Phone	(33) 1-64-46-00-85
Fax	(33) 1-64-46-94-38
E-mail	info@harvardapparatus.fr

Germany

Hugo Sachs Elektronik

Gruenstrasse 1
March-Hugstetten D-79232, Germany

Phone	(49) 0 7665.92.00.0
Fax	(49) 0 7665.92.00.90
E-mail	info@hugo-sachs.de
Web	www.hugo-sachs.de

Sweden

CMA Microdialysis AB

Torshamnsgatan 30A
SE-164 40 KISTA, Sweden

Phone	+46.8.470.10.00
E-mail	cma@microdialysis.se
Web	www.microdialysis.com

Spain

Panlab S.L.U.

C/ Energia, 112
08940 Cornellà (Barcelona), Spain

Phone	+46 8 470 10 00
Fax	+46 8 470 10 50
E-mail	info@panlab.com
Web	www.panlab.com

United Kingdom

Biochrom

1020 Cambourne Business Park
Cambourne, Cambridge, CB23 6DW UK

Phone	(44) 1223.423.723
Fax	(44) 1223.420.164
E-mail	enquiries@biochrom.co.uk
Web	www.biochrom.co.uk

China

Harvard Apparatus China

Room 1902E • 19F, Building B
Zhong Shan Plaza
1065 West Zhong Shan Road
Changning District
Shanghai, China 200051

Phone	+86 21 2230 5128
-------	------------------